









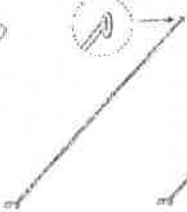
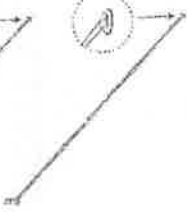

Part # CT-WSHBN XX+XX

18-0418

PARTS					TOOLS		
							
A	B	C	D	E	F x8 M6 15mm	H x2	J
							
					G x2 M8 30mm	I x2	

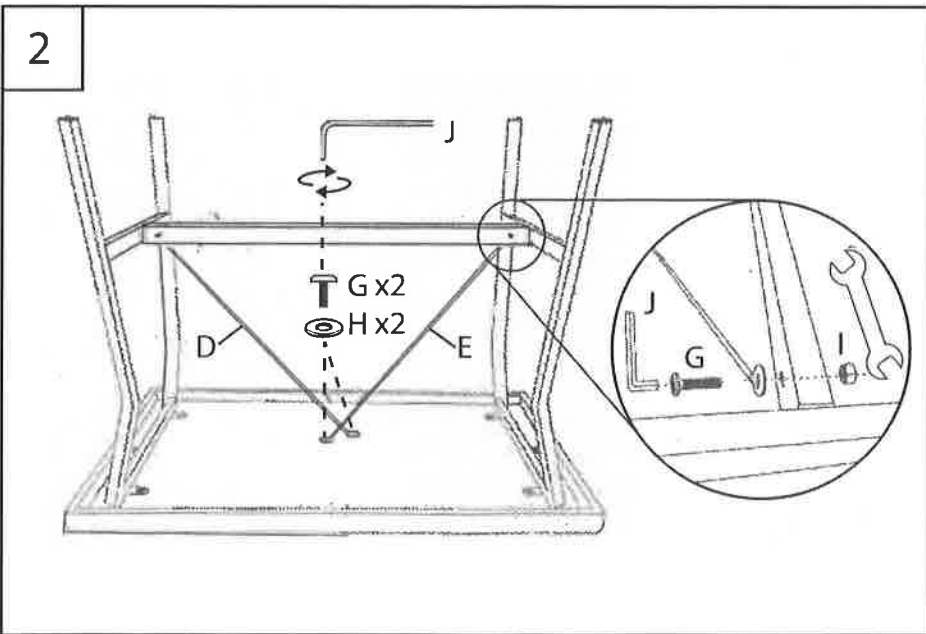
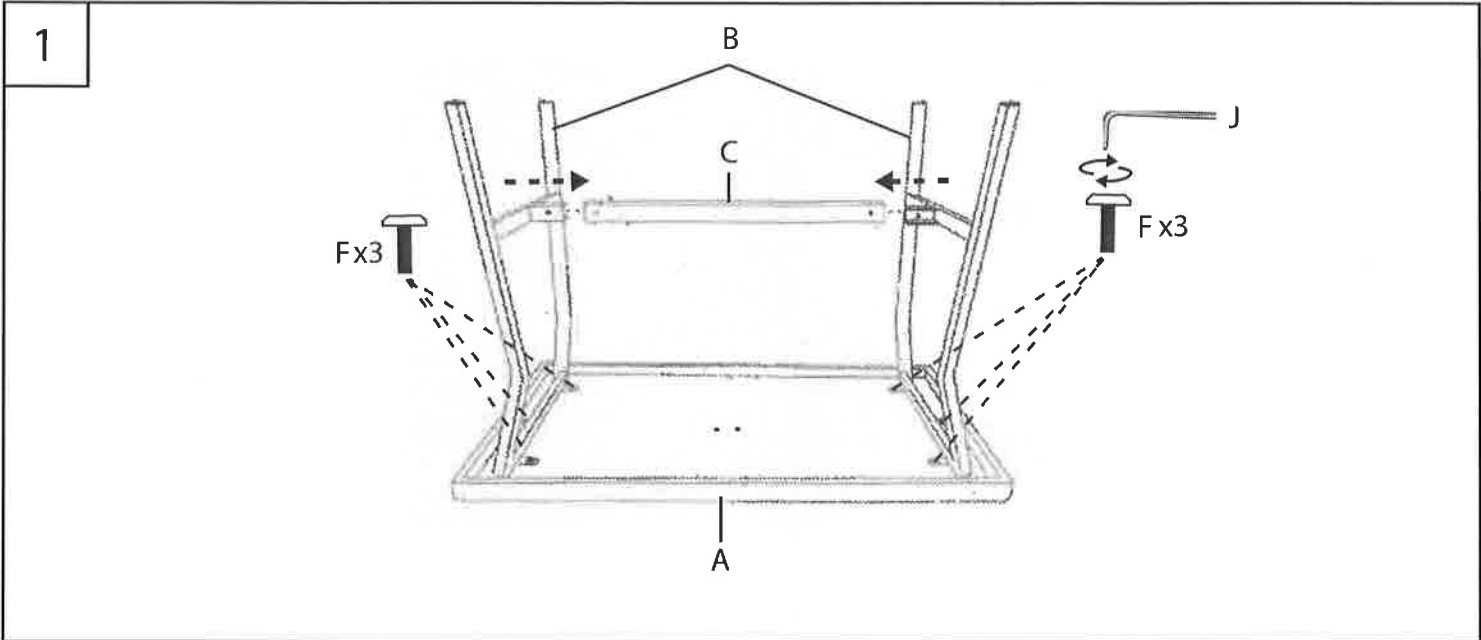

 Do not over tighten.
 Do not use power tools to assemble.