

IMPORTANT SAFETY INSTRUCTIONS

When using electrical products, basic precautions should always be followed including the following:

a) READ AND FOLLOW ALL SAFETY INSTRUCTIONS

- b) Do not use seasonal products outdoors unless marked suitable for indoor and outdoor use. When products are used in outdoor applications, connect the product to a Ground Fault Circuit Interrupting (GFCI) outlet. If one is not provided, contact a qualified electrician for proper installation.
- c) This seasonal use product is not intended for permanent installation or use.
- d) Do not mount or place near gas or electric heaters, fireplaces, candles or other similar sources of heat.
- e) Do not secure the wiring of the product with staples or nails, or place on sharp hooks or nails.
- f) Do not let lamps rest on the supply cord or on any wire.
- g) Unplug the product when leaving the house, when retiring for the night, or if left unattended.
- h) This is an electric product - not a toy! To avoid risk of fire, burns, personal injury and electric shock it should not be played with or placed where small children can reach it.
- i) Do not use this product for other than its intended use.
- j) Do not hang ornaments or other objects from cord, wire, or light string.
- k) Do not close doors or windows on the product or extension cords as this may damage the wire insulation.
- l) Do not cover the product with cloth, paper or any material not part of the product when in use.
- m) This product is equipped with push-in type lamps. Do not twist lamps.
- n) This product employs overload protection (fuse). A blown fuse indicates an overload or short-circuit situation. If the fuse blows, unplug the product from the outlet. Also unplug any additional strings or products that may be attached to the product. Replace the fuse as per the user servicing instructions (follow product marking for proper fuse rating) and check the product. If the replacement fuse blows, a short-circuit may be present and the product should be discarded.
- o) Read and follow all instructions that are on the product or provided with the product.

p) SAVE THESE INSTRUCTIONS

Use And Care Instructions

- a) When the product is placed on a live tree, the tree should be well maintained and fresh. Do not place on live trees in which the needles are brown or break off easily. Keep the tree holder filled with water.
- b) If the product is placed on a tree, the tree should be well secured and stable.
- c) Before using or reusing, inspect product carefully. Discard any products that have cut, damaged, or frayed wire insulation or cords, cracks in the lampholders or enclosures, loose connections, or exposed copper wire.
- d) When storing the product, carefully remove the product from wherever it is placed, including trees, branches or bushes, to avoid any undue strain or stress on the product conductors, connections, and wires.
- e) When not in use, store neatly in a cool, dry location protected from sunlight.

User Servicing Instructions

Replace the fuse.

- a) Grasp plug and remove from the receptacle or other outlet device. Do not unplug by pulling on the cord.
- b) Open fuse cover. Slide open the fuse access cover on top of the attachment plug towards blades.
- c) Remove fuse carefully.
- d) Risk of fire. Replace fuse only with 3 Amp, 125 Volt fuse (provided with product).
- e) Close fuse cover. Slide closed the fuse access cover on top of attachment plug.
- f) Risk of fire. Do not replace attachment plug. Contains a safety device (fuse) that should not be removed. Discard product if the attachment plug is damaged.

Replace the lamp.

- a) Grasp plug and remove from the receptacle or other outlet device. Do not unplug by pulling on cord.
- b) Pull lamp and plastic base straight out of lampholder.
- c) Replace lamp with only 3.0 Volt, 0.072 Watt LED type lamp (provided with product).

If the new lamp base does not fit in lampholder, follow the steps below before step 3.

- a) Remove the base of burned out lamp by straightening lamp leads and gently pull lamp out.
- b) Thread leads of new lamp through holes in old base with one lead in each hole.
- c) After lamp is fully inserted into base, bend each lead up, like other lamps in the light set so that the leads will touch the contacts inside the lampholder.

CAUTION:

- 1. Risk of fire. This product does not contain lamp shunts, which allow the product to operate if one lamp burns out. Do not replace lamps with other than the spare lamps provided with this product.
- 2. To reduce the risk of fire and electric shock: a) Do not install on trees having needles, leaves or branch coverings of metal or materials which look like metal. b) Do not mount or support strings in a manner can cut or damage wire insulation.

CAUTION:

- 1. Replace lamps only with 3.0 Volt, 0.072 Watt spare lamps provided with this product.
- 2. If the supply core is damaged, it must be replaced by the manufacturer, its service agent or similar qualified persons in order to avoid a hazard.

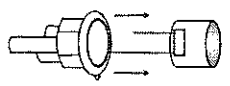
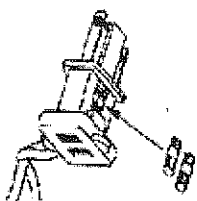

Red Ornament Assembly Instructions

1. Remove all components from the box and lay them flat on the floor (Fig.1).

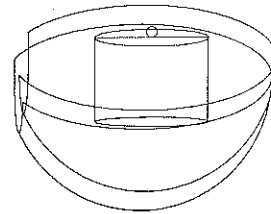

Fig.1

2. Attach the two halves of the ornament body together by using plastic tie as shown (Fig.2).

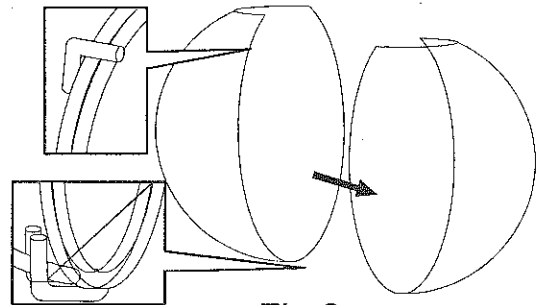

Fig.2

3. Attach the topper to the ornament using the prongs as shown (Fig.3).

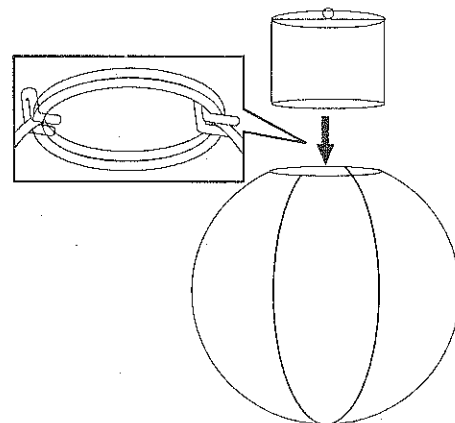

Fig.3

4. Hang in desired location or use included stakes to secure into ground (Fig.4).

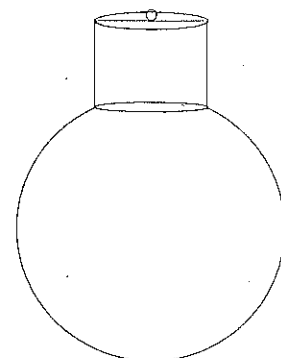
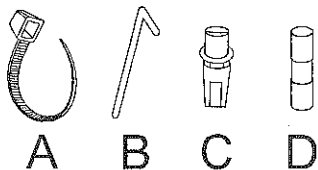

Fig.4



Accessories/spare parts
A-Plastic Ties;
B-Ground Stake;